

The API

7600

**Input
Strip**

A BASIC OVERVIEW OF THE API 7600 INPUT STRIP

Thank you for choosing the API 7600 INPUT STRIP. The 7600 is a complete input module that can be used as a stand-alone input strip or as a console with as few as 2 inputs to as many inputs as desired. When used with the 7800 MASTER CONTROL module, a complete console can be built with Solo features, Mute Groups, Master send control, Bus masters, Cue and Talkback and a complete control room speaker monitoring section with input and tape monitoring.

The 7600 includes everything needed to record a signal. The 212L Mic Preamp is exactly the same unit as is used in the famed LEGACY console, and is available as a stand alone unit for the L200 series rack system.

Next in line is the 550A equalizer section. This is an exact re-issue of the API 550A equalizer. As a 3 band unit, the 550A had 5 frequencies per channel, to which we have added 2 additional frequency selections per band. We also have added a discrete balanced input stage before the original unbalanced stage for obvious reasons. This circuitry within the equalizer is identical to the original 1970's era equalizer that brought us that famous "LA" sound.

With the addition of the L200 series, API designed the 225L compressor, which we have also included in the 7600 strip. The 225L has many features not found on any other units available in the world. You can select the "hardness" of the knee where the compression effect starts, and you can select the unique "OLD" or "NEW" compression types. This "NEW/OLD" control sets the TYPE, or where the signal for the RMS detector comes from. In the NEW mode, the compressor works like most newer types of compressors, as in most of the VCA based units. This is called FEED-FORWARD compression, where the RMS detector sends a signal to the VCA that is an exact ratio of the desired compression, set by the RATIO control. When the OLD position is selected, the RMS detector gets the signal from the output of the VCA, and then feeds the VCA a signal based on a set ratio of that signal. This type of compression is called FEED-BACK compression and is how the older API 525, 1176 type and 660 type compressors worked. The NEW mode is much harder and the OLD mode is very smooth. When SOFT Knee and OLD is selected you can hardly hear the compression.

The 7600 also has a Stereo Bus and 4 Track Busses. 2 7600's can simply mult the bus outputs together and more than 2 units can hook up to the 7800 Master Section. Between the 4 Sends, the 4 Track Busses and the Stereo Bus, there are 10 bussable outputs from the 7600.

All of the patchable outputs are with 1/4 inch normalizing jacks, so an external patchbay can be interfaced with several units. The DIR out and the MIC input are XLR jacks. The Busses and control ports are on mass termination connectors or D-Sub connectors conforming to the DA-88 pin-out. The external fader jack is a 1/4 inch jack that bypasses the internal rotary pot.

The 7600 is the first of it's kind available in the world. This unique module allows anyone to assemble an API Legacy type console, module by module, or build a great sounding portable tracking/mixing rack. When used with the 7800 Master Section, you can build a complete console, one piece at a time as time and money allows.

Input and Send Section

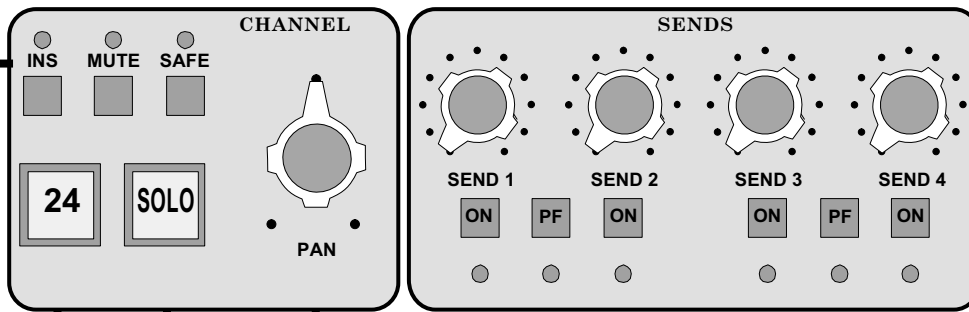

PAN:

This switch switches on the PAN pot feeding the STEREO bus and the BUS assigns outputs. It drops the signal 3dB at the center point.

24 and SOLO:

The "24" switch is a MUTE switch, which mutes the entire channel and can be used to control an external automation system allowing mute writes along with fader moves. It can also be used as an additional mute group logic input.

The SOLO button engages the solo logic provided in the 7800 MASTER Section, allowing full SOLO control of the 7600.

INS:

This switch inserts a device that is plugged into the rear INSERT jacks.

MUTE:

This switch turns on an external MUTE GROUP function, allowing linked channels to mute via a remote control switch.

SAFE:

This switch prevents the channel from muting when in the Solo In Place Mode and is used with the 7800 MASTER section and several other

SENDS:

These switches and pots control the amount of level sent out the rear connector panel to the effect inputs. They can be bussed together either resistively or with the 7800 MASTER Section. The switches control ON and OFF, and PRE or POST fader to the pots.

550 A Equalizer Section

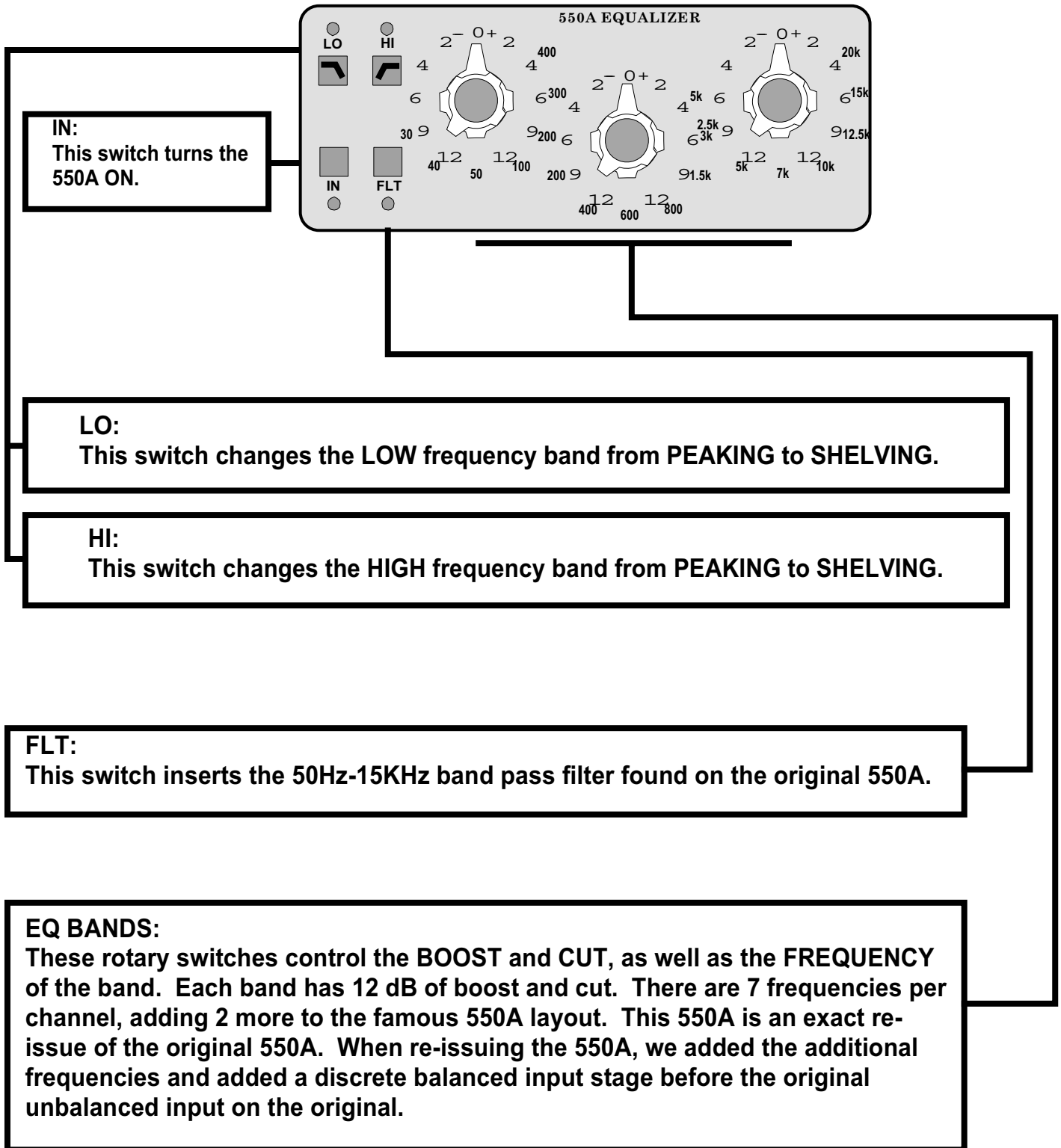

225L Compressor Section

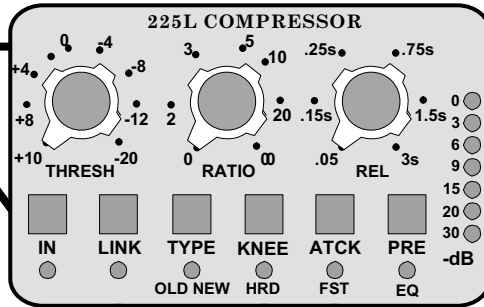

IN:
This hard relay bypass switch turns the 225L ON.

LINK:
This switch links the 225L to other units. It is available on a 1/4" phone jack.

THRESH:
This control sets the THRESHOLD from +10 dBu to -20 dBu. This control is continuously variable. The THRESH control also effects the output gain, always keeping the output gain at UNITY

RATIO:
This control sets the compression RATIO of each channel from 0 to INF:1 or above 20:1. This control allows repeatability while offering a wide range of settings. The RATIO control also effects the output gain, always keeping the output gain at UNITY.

RELEASE:
This control sets the RELEASE of the compressor, covering a wide range of release times. It has a range from .05 seconds to 3 seconds.

TYPE: SEE PAGE 8
This control sets the TYPE, or where the signal for the RMS detector comes from. In the NEW mode, the compressor works like most newer types of compressors, as in most of the VCA based units. This is called FEED-FORWARD compression, where the RMS detector sends a signal to the VCA that is an exact ratio of the desired compression, set by the RATIO control. When the OLD position is selected, the RMS detector gets the signal from the output of the VCA, and then feeds the VCA a signal based on a set ratio of that signal. This type of compression is called FEED-BACK compression and is how the older API 525, 1176 type and 660 type compressors worked. The NEW mode is much harder and the OLD mode is very smooth. When SOFT Knee and OLD is selected you can hardly hear the compression.

KNEE: SEE PAGE 9
This control sets the KNEE, or how the point where the compressor begins to reduce the gain of the signal applied to the unit. When in the HARD position, the gain reduction begins at the set ratio and is a sharp transition into compression. The SOFT position has a gradual "fade-in" to the set ratio. The SOFT position is very subtle and similar to an "over-easy" type KNEE.

ATTACK:
This control sets the ATTACK time of each channel from 30 micro-seconds (FAST) or 10 milli-seconds (SLOW). This switch allows repeatability, while offering a wide range of settings.

PRE EQ:
This switch places the 225L BEFORE the 550A EQ. It is normally AFTER the EQ.

VU METER:
This LED display shows COMPRESSION amount or GAIN REDUCTION.

212L MIC PREAMP Section

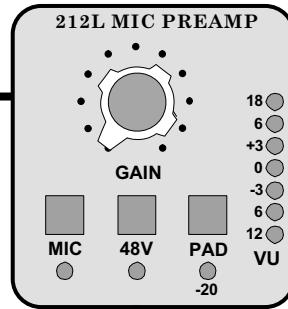

GAIN:

This control adjusts the GAIN of the MIC Preamp. There is a total of 60 dB of gain available.

MIC:

This switch switches the input to the Preamp input stage. When IN, it selects the LO-Z xlr MIC Input, unless a 1/4" plug is inserted into the HI-Z Instrument Input, then it switches to the HI-Z input for a direct instrument input. When the switch is OUT, the LO-Z 1/4" balanced phone jack LINE In is selected.

48V:

This switch turns on the 48 Volt Phantom Power for the MIC input.

PAD:

This switch inserts a -20dB resistive PAD in the MIC input. The PAD is out of the circuit when the switch is OUT.

VU METER:

This LED display shows the OUTPUT level of the MIC Preamp OUTPUT, with the "0" LED referenced to +4dBu.

Output Section

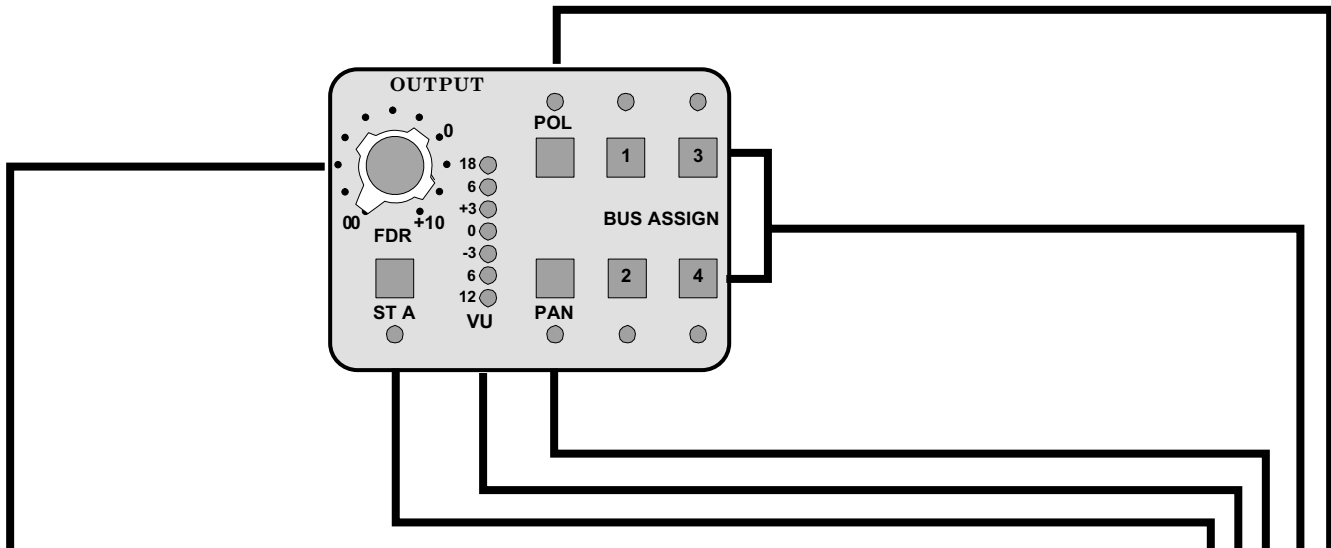

FADER:

This control is the final output control that feeds the Panner, the Post-Fader sends and the DIRECT output. There is a jack on the rear panel to replace this control with linear fader if desired.

ST A:

This switch turns on the STEREO bus for this module and enables the solo-in-place mute on the channel.

VU METER:

This LED display shows the OUTPUT level of the channel and DIRECT out, with the "0" LED referenced to +4dBu.

PAN:

This switch switches on the PAN pot feeding the STEREO bus and the BUS assigns outputs. It drops the signal 3dB at the center point.

BUS ASSIGN:

These switches turn on the 4 BUSSES that feed out of the rear bus connector. When used in the Mini-Legacy Console, there are 12 BUSSES.

POLARITY:

This switch flips the phase of the signal at the Preamp Out Patch where it will effect all parts of the signal path.

Compression KNEE at the Threshold Point

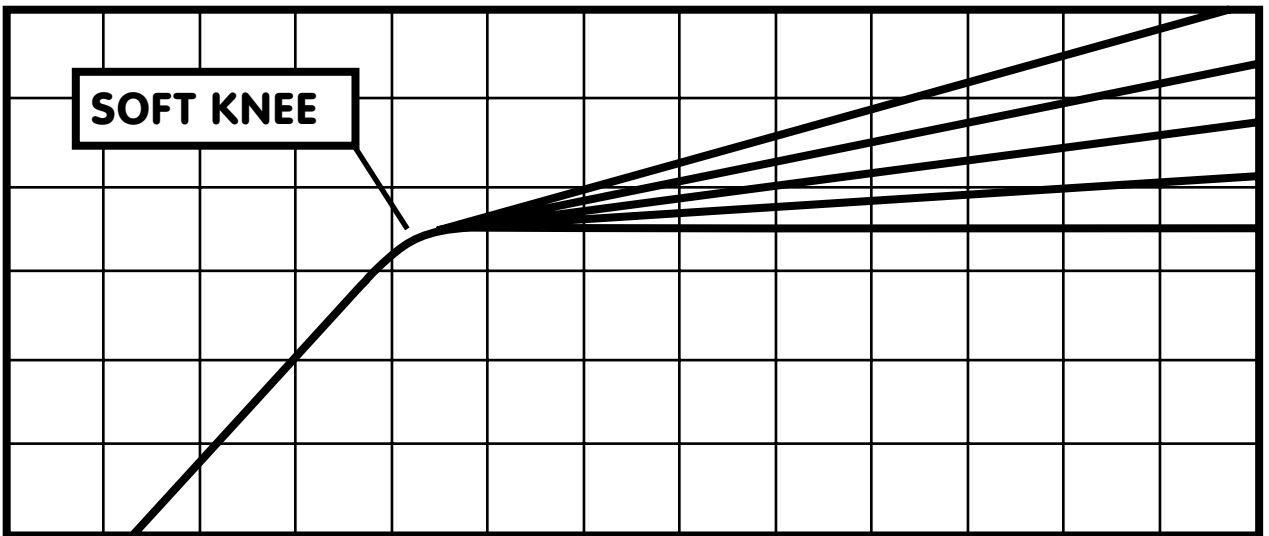
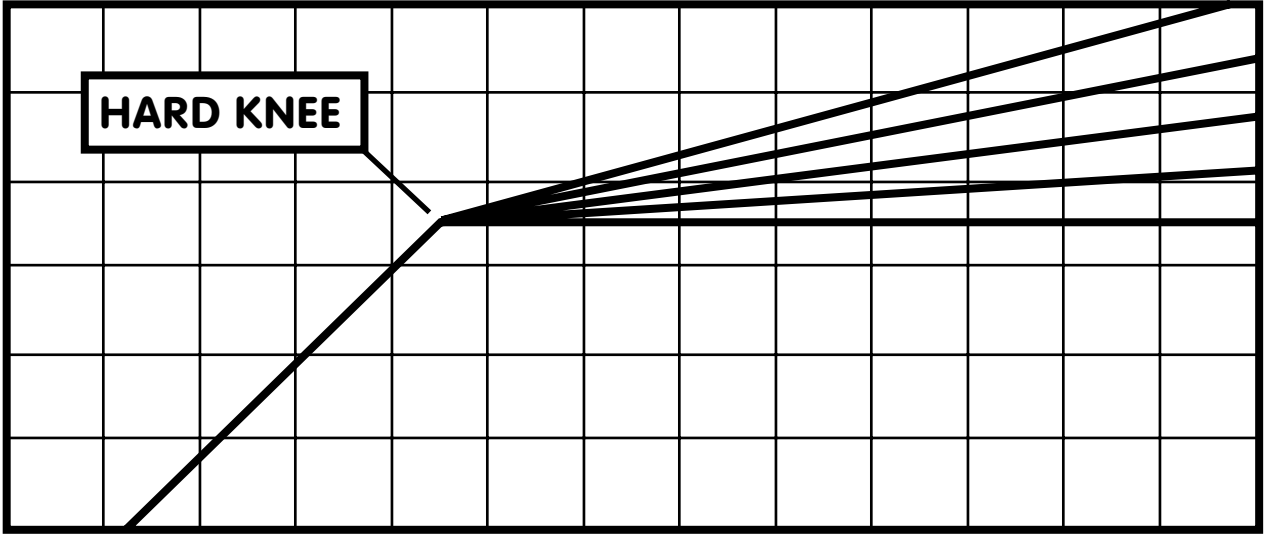

"NEW" or FEED FORWARD type COMPRESSION

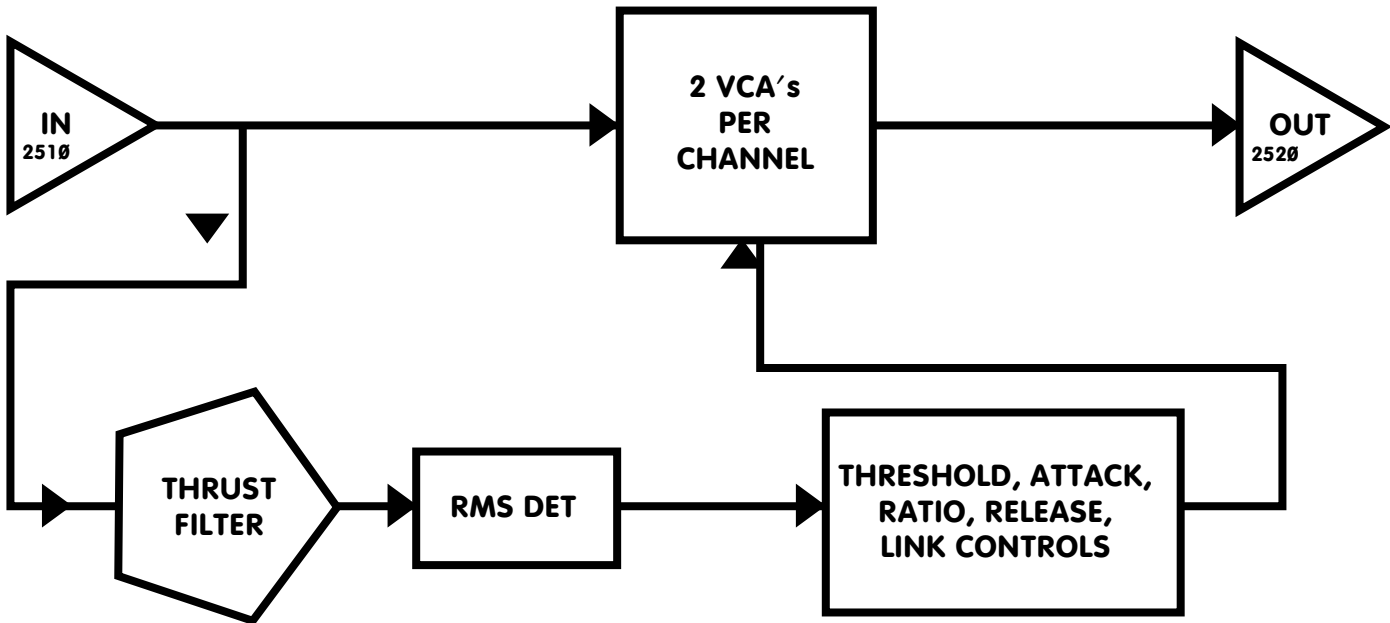

"OLD" or FEED BACK type COMPRESSION

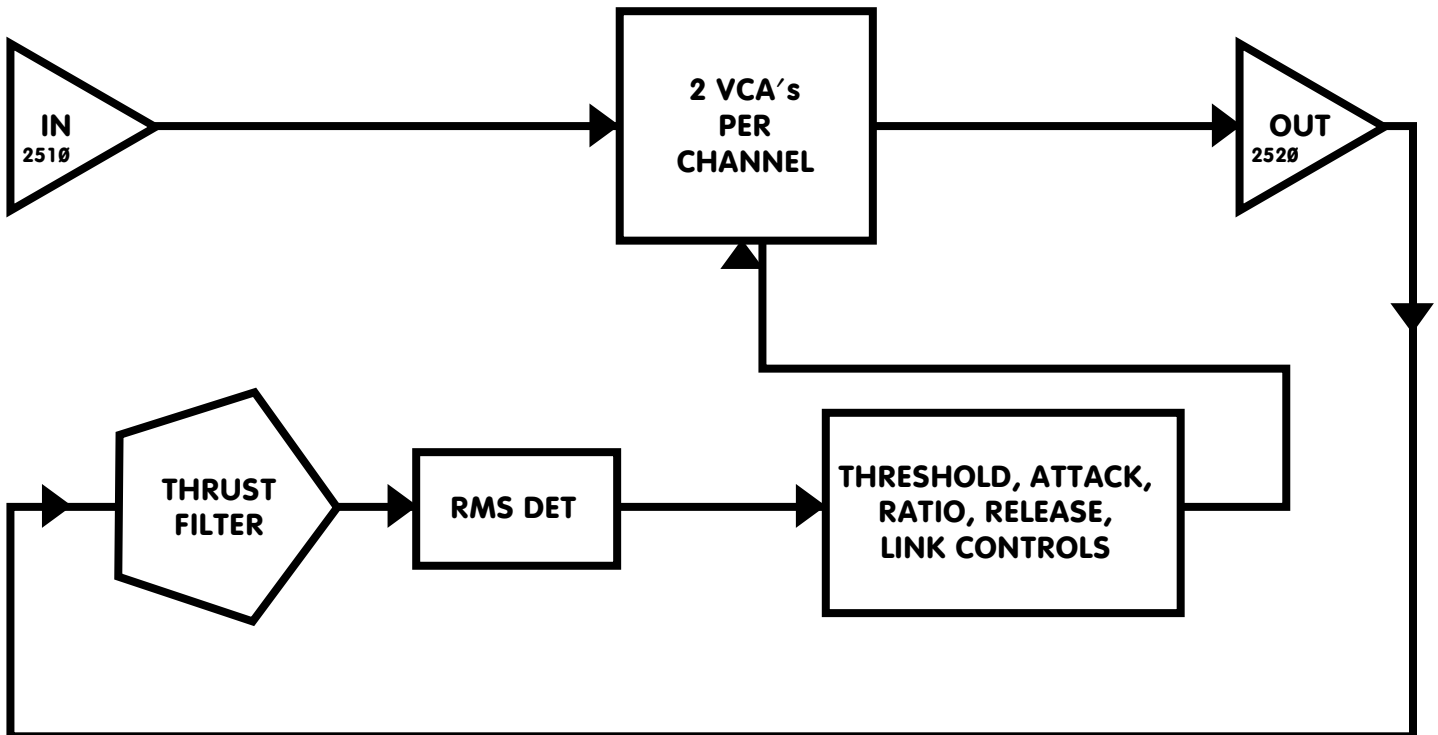

7600 REAR PANEL

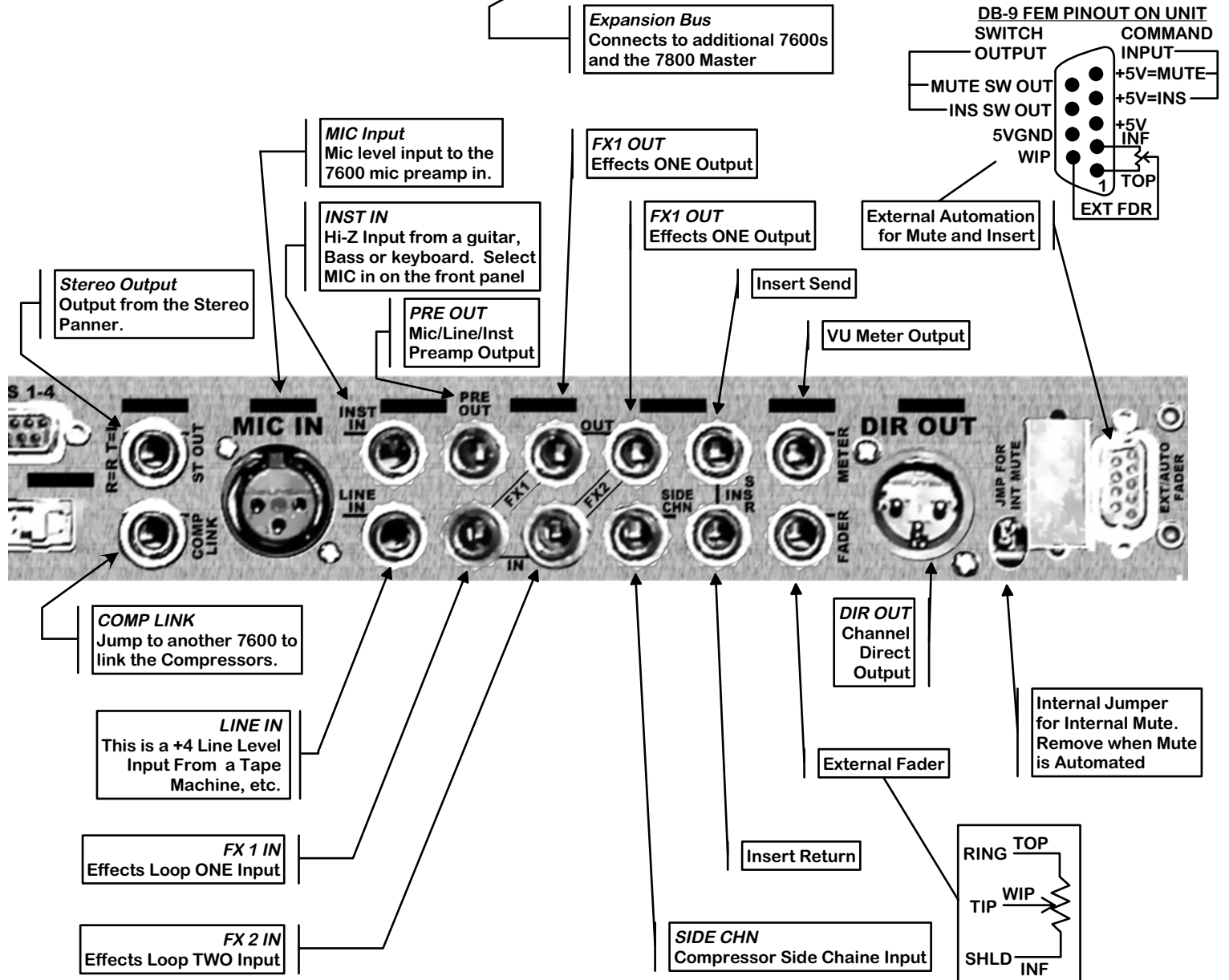
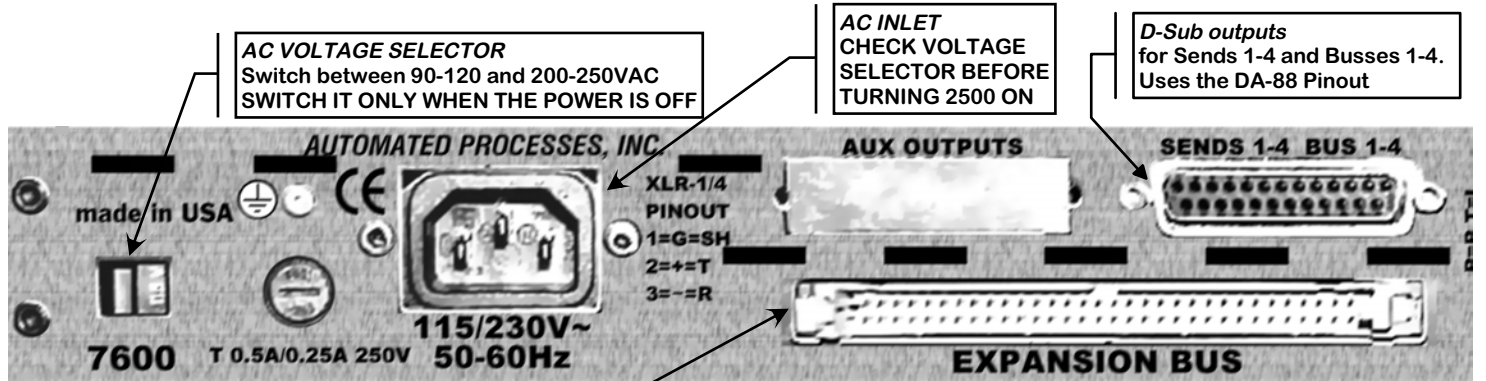

Record the serial number of your 7600 in the space below for your records. Should you ever need to contact the factory about this unit, please have this number handy.

serial no. found on rear _____

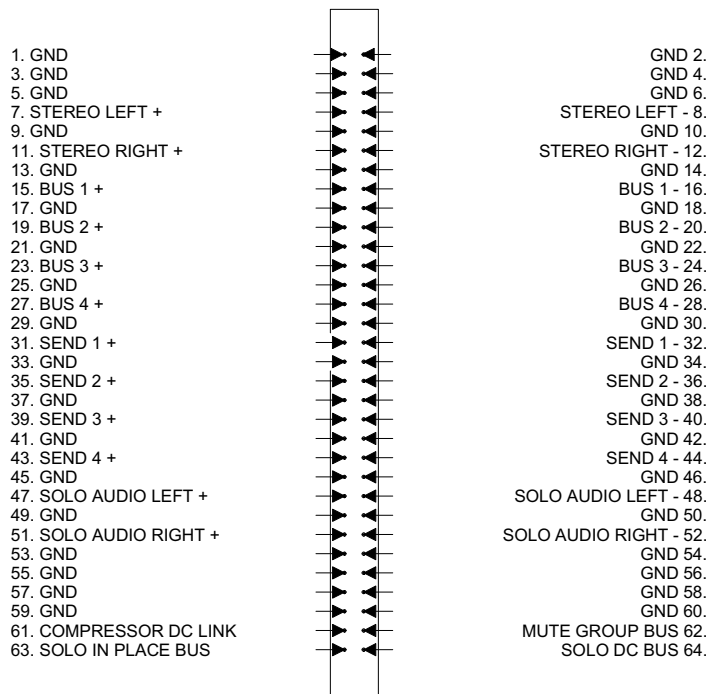

7600 BUS CONNECTOR PINOUT

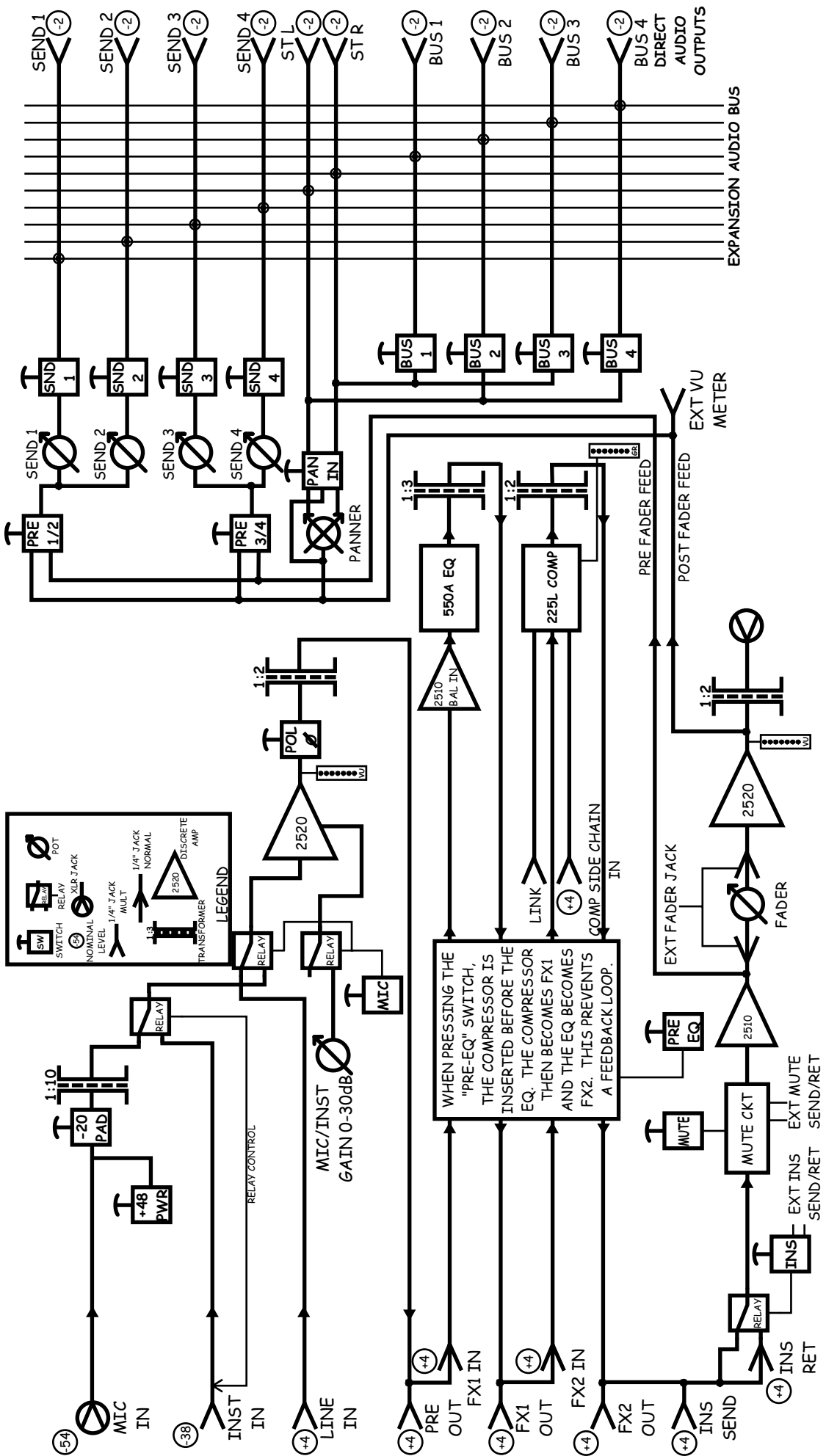

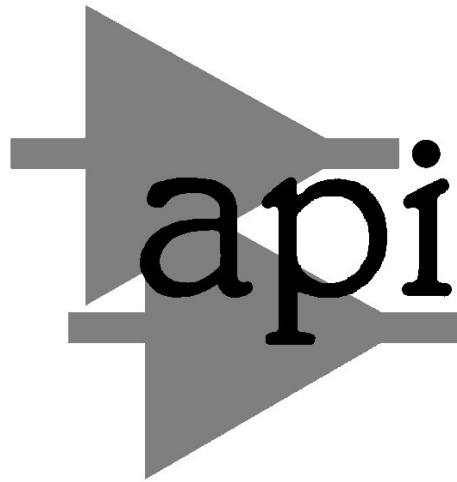

**API is part of the ATI Group, 8301 Patuxent Range Road, Jessup, MD 20794 Tel: 301-776-7879
www.apiaudio.com**

In a constant effort to improve the subtle details of our products, some amount of change is inevitable.
API reserves the right to modify or change any of the features, specifications or performance of its products without notice or obligation.